

**SMAG Plastic-Encapsulate Diodes****SMA59 SERIES** Zener Diodes**Features**

- P_{tot} 3W
- V_Z 3.3V- 200V
- The marking bar indicates the cathode

Applications

- Stabilizing Voltage

Marking

- SMA59XXB
XX : From 13 To 56

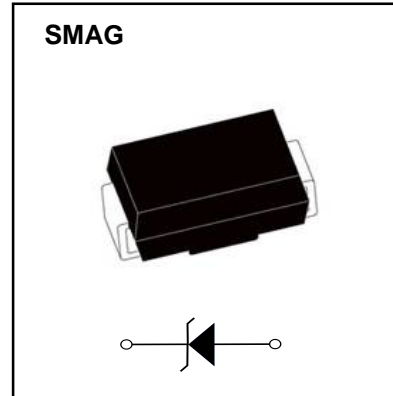
**Limiting Values(Absolute Maximum Rating)**

Item	Symbol	Unit	Conditions	Max
Power dissipation	P_d	W	$T_L=75^\circ\text{C}$	3.0
Zener current	I_Z	mA		P_V / V_Z
Operation Junction and Storage Temperature Range	T_J, T_{stg}	$^\circ\text{C}$		-55 ~ +150

Electrical Characteristics ($T_a=25^\circ\text{C}$ Unless otherwise specified)

Item	Symbol	Unit	Conditions	Max
Thermal resistance	$R_{\theta JA}$	$^\circ\text{C/W}$	Between junction to ambient	75
	$R_{\theta JL}$	$^\circ\text{C/W}$	Between junction to lead	30
Forward voltage	V_F	V	$I_F=200\text{mA}$	1.2

Electrical Characteristics ($T_A=25^\circ\text{C}$ unless otherwise noted)

Part Number	Nominal Zener Voltage		Maximum Zener Impedance			Maximum Reverse Leakage Current		Maximum DC Zener Current
	$V_Z @ I_{ZT}$	I_{ZT}	$Z_{ZT} @ I_{ZT}$	$Z_{ZK} @ I_{ZK}$	I_{ZK}	$I_R @ V_R$		I_{ZM}
	(V)	(mA)	(Ω)	(Ω)	(mA)	(μA)	(V)	(mA)
SMA5913B	3.3	227.3	10.0	500	1.00	100.0	1.0	817
SMA5914B	3.6	208.3	9.0	500	1.00	75.0	1.0	749
SMA5915B	3.9	192.0	4.5	400	1.00	50.0	1.0	691
SMA5916B	4.3	174.0	4.5	400	1.00	30.0	1.0	627
SMA5917B	4.7	160.0	4.0	500	1.00	20.0	1.0	573
SMA5918B	5.1	147.0	3.5	550	1.00	5.0	1.0	528
SMA5919B	5.6	134.0	2.5	600	1.00	5.0	2.0	481
SMA5920B	6.2	121.0	1.5	700	1.00	5.0	3.0	435
SMA5921B	6.8	110.0	2.0	700	1.00	5.0	4.0	393
SMA5922B	7.5	100.0	2.0	700	0.50	5.0	5.0	360
SMA5923B	8.2	91.0	2.3	700	0.50	5.0	6.0	330
SMA5924B	9.1	82.0	2.5	700	0.50	3.0	7.0	297
SMA5925B	10.0	75.0	3.5	700	0.25	3.0	7.6	270
SMA5926B	11.0	68.0	4.0	700	0.25	1.0	8.4	225
SMA5927B	12.0	63.0	4.5	700	0.25	1.0	9.1	246
SMA5928B	13.0	58.0	4.5	700	0.25	0.5	9.9	208
SMA5929B	15.0	50.0	5.5	700	0.25	0.5	11.4	180
SMA5930B	16.0	47.0	5.5	700	0.25	0.5	12.2	169
SMA5931B	18.0	42.0	6.0	750	0.25	0.5	13.7	150
SMA5932B	20.0	37.0	7.0	750	0.25	0.5	15.2	135
SMA5933B	22.0	34.0	8.0	750	0.25	0.5	16.7	123
SMA5934B	24.0	31.0	9.0	750	0.25	0.5	18.2	112
SMA5935B	27.0	28.0	10.0	750	0.25	0.5	20.6	100
SMA5936B	30.0	25.0	16.0	1000	0.25	0.5	22.5	90
SMA5937B	33.0	23.0	20.0	1000	0.25	0.5	25.1	82
SMA5938B	36.0	21.0	22.0	1000	0.25	0.5	27.4	75
SMA5939B	39.0	19.0	28.0	1000	0.25	0.5	29.7	69
SMA5940B	43.0	17.0	33.0	1500	0.25	0.5	32.7	63
SMA5941B	47.0	16.0	38.0	1500	0.25	0.5	35.6	57
SMA5942B	51.0	15.0	45.0	1500	0.25	0.5	38.8	53
SMA5943B	56.0	13.0	50.0	2000	0.25	0.5	42.6	48
SMA5944B	62.0	12.0	55.0	2000	0.25	0.5	47.1	44
SMA5945B	68.0	11.0	70.0	2000	0.25	0.5	51.7	40
SMA5946B	75.0	10.0	85.0	2000	0.25	0.5	56.0	36
SMA5947B	82.0	9.1	95.0	3000	0.25	0.5	62.2	33
SMA5948B	91.0	8.2	115	3000	0.25	0.5	69.2	30
SMA5949B	100.0	7.5	160	3000	0.25	0.5	76.0	27
SMA5950B	110.0	6.8	225	4000	0.25	0.5	83.6	25
SMA5951B	120.0	6.3	300	4500	0.25	0.5	91.2	22
SMA5952B	130.0	5.8	375	5000	0.25	0.5	98.8	21
SMA5953B	150.0	5.0	550	6000	0.25	0.5	114.0	18
SMA5954B	160.0	2.3	700.0	6500	0.25	0.5	121.6	9
SMA5955B	180.0	2.1	900.0	7000	0.25	0.5	136.8	8
SMA5956B	200.0	1.9	1200.0	8000	0.25	0.5	152.0	7

Notes :

- (1) The type number listed have a standard tolerance on the nominal zener voltage of $\pm 5\%$
- (2) The reverse surge current is a non-repetitive, 8.3ms pulse width square wave or equivalent sine-wave superimposed on I_{ZT} per method.

Typical Characteristics

Fig. 1 - Power Temperature Derating Curve

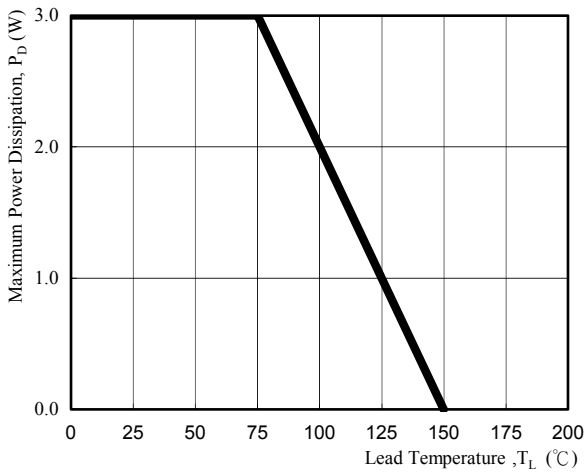

Fig. 2 - Temperature Coefficients v.s. Zener Voltage

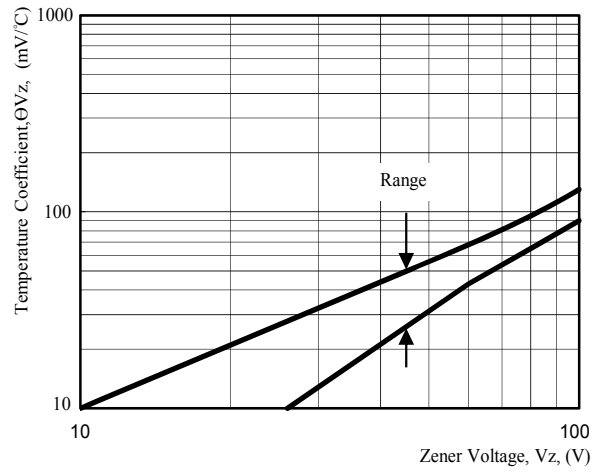

Fig. 3 - Typical Thermal Resistance v.s. Lead Leng



Fig. 4 - Maximum Surge Power

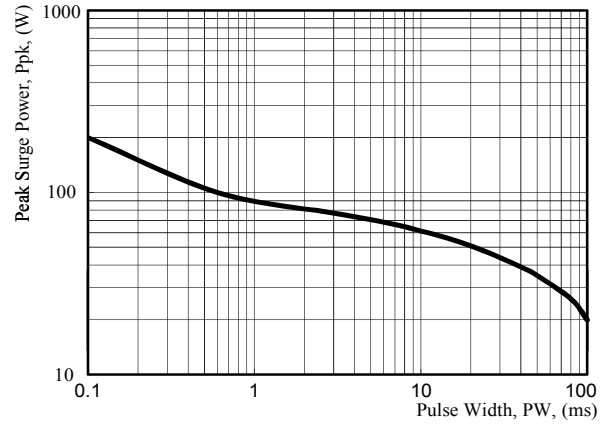
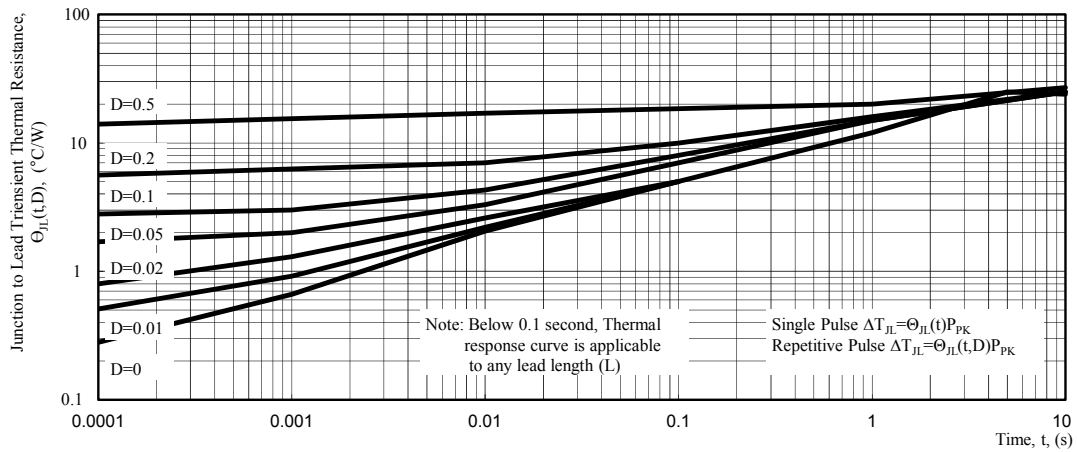
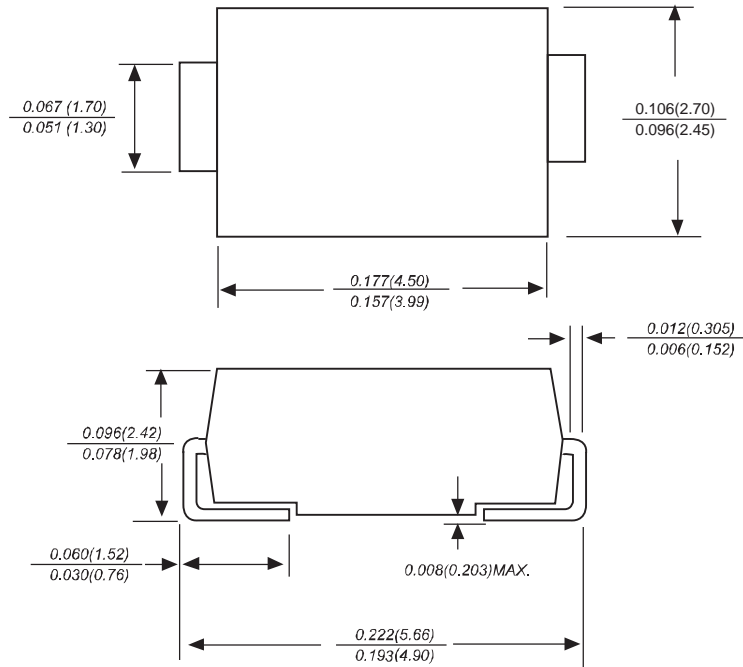

Fig. 5 - Typical Thermal Response L, Lead Length=3/8inch



SMAG Package Outline Dimensions



Dimensions in inches and (millimeters)

SMAG Suggested Pad Layout

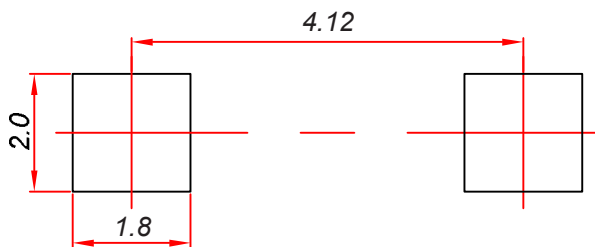

Note:

1. Controlling dimension: in millimeters.
2. General tolerance: ± 0.05 mm.
3. The pad layout is for reference purposes only.

NOTICE

JSCJ reserves the right to make modifications, enhancements, improvements, corrections or other changes without further notice to any product herein. JSCJ does not assume any liability arising out of the application or use of any product described herein.

Reel Taping Specifications For Surface Mount Devices- SMAG

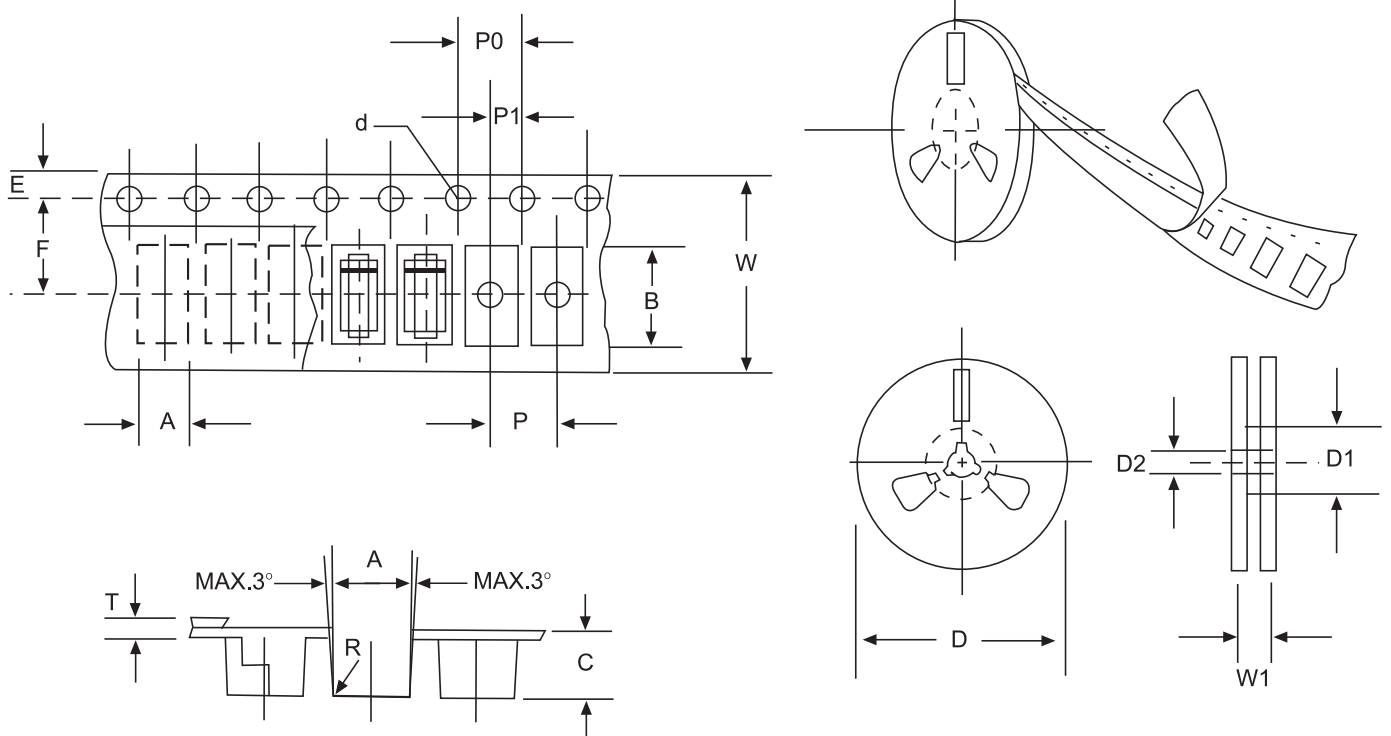

FIG: CONFIGURATION OF SURFACE MOUNTED DEVICES TAPING

ITEM	SYMBOL	SMAG mm(inch)
Carrier width	A	2.79±0.1(0.110±0.004)
Carrier length	B	5.33±0.1(0.210±0.004)
Carrier depth	C	2.36±0.1(0.093±0.004)
Sprocket hole	d	1.55±0.05(0.061±0.002)
Reel outside diameter	D	279±2.0 (11± 0.079)
Reel inner diameter	D1	75 ±1.0 (2.95 ±0.039)
Feed hole diameter	D2	13±0.5(0.512±0.020)
Stroket hole position	E	1.75±0.1(0.069±0.004)
Punch hole position	F	5.5±0.05(0.217±0.002)
Punch hole pitch	P	4.0±0.1(0.157±0.004)
Sprocket hole pitch	P0	4.0±0.1(0.157±0.004)
Embossment center	P1	2.0±0.1(0.079±0.004)
Totall tape thickness	T	0.28±0.02(0.011 ±0.0008)
Tape width	W	12.0±0.2(0.472±0.008)
Reel width	W1	16.8±2.0(0.661±0.079)

NOTE: Devices are packed in accordance with EIA standard RS-481-A and specification given above.